

Back

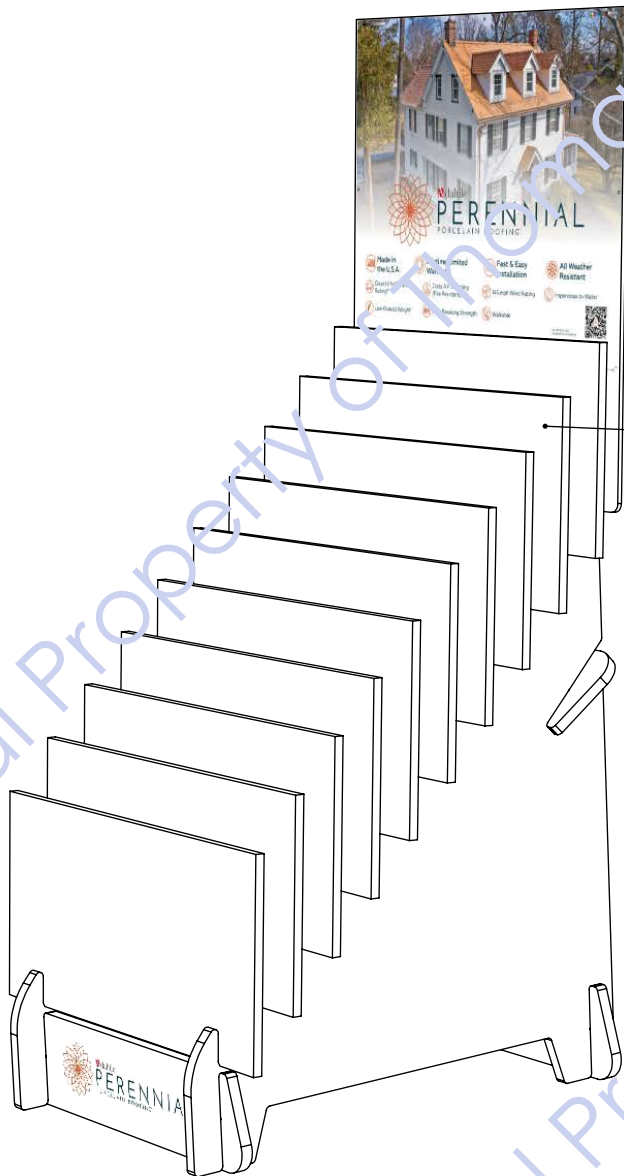

22-1/2" WIDE X 11-1/4" TALL

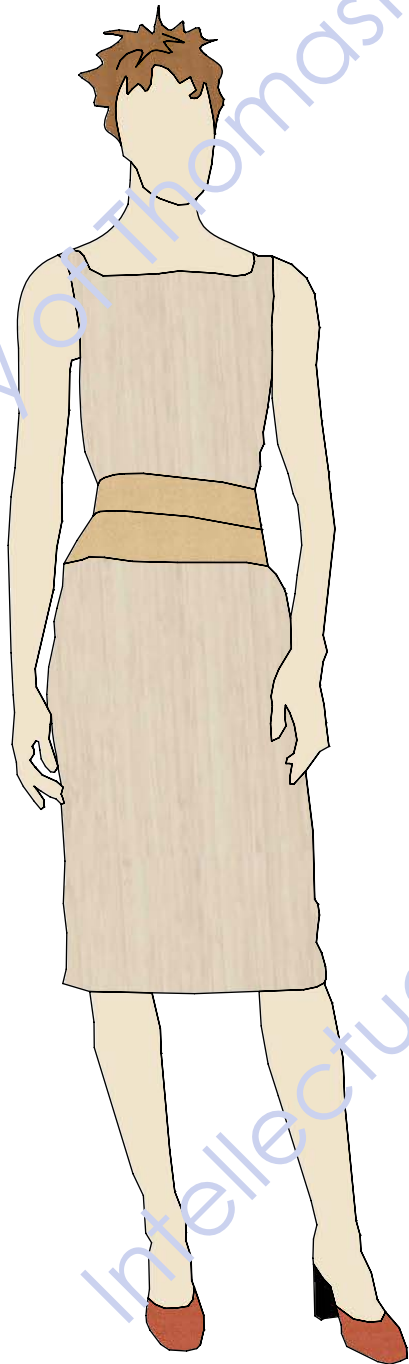

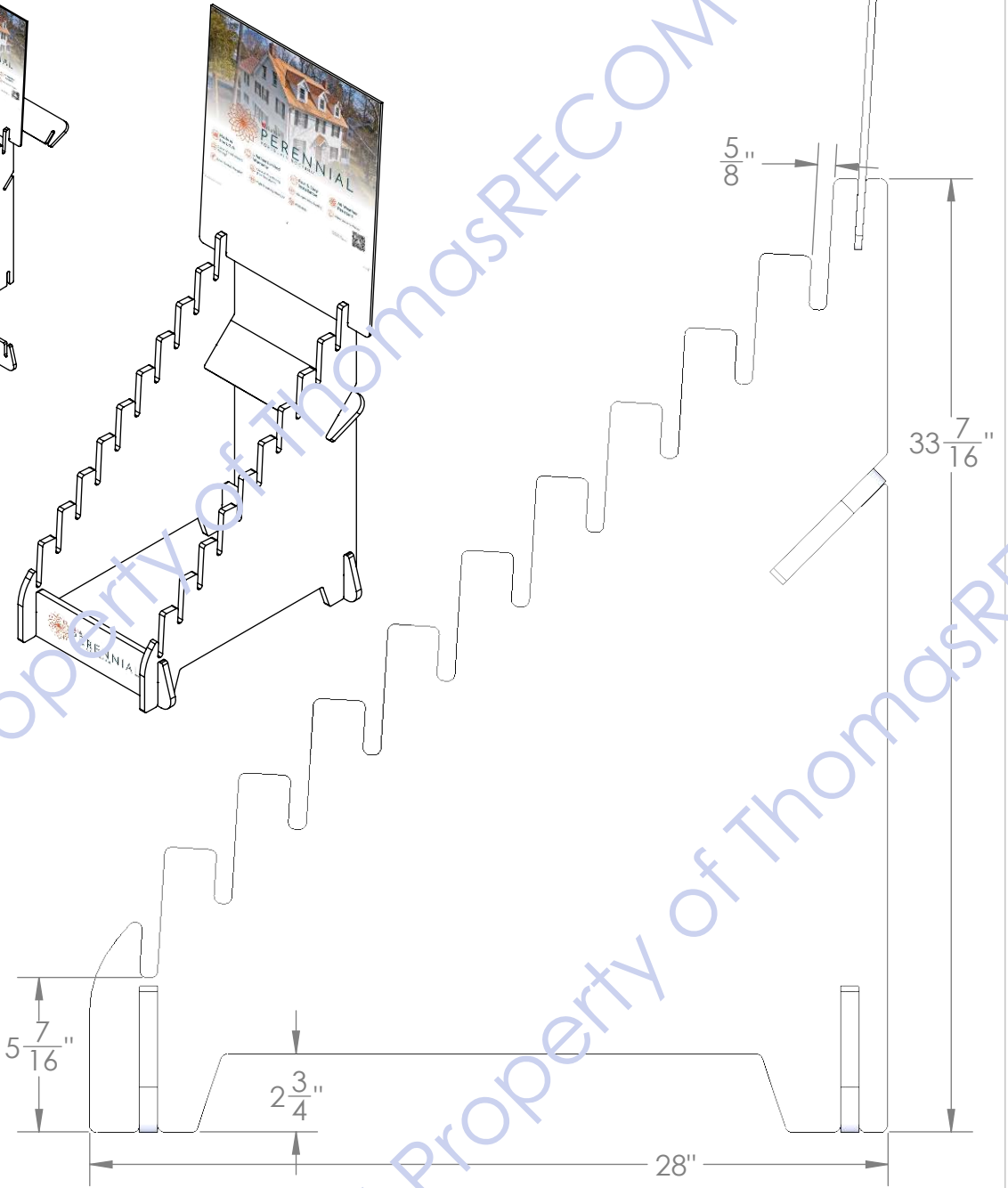
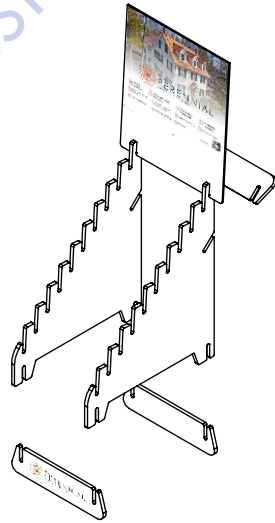
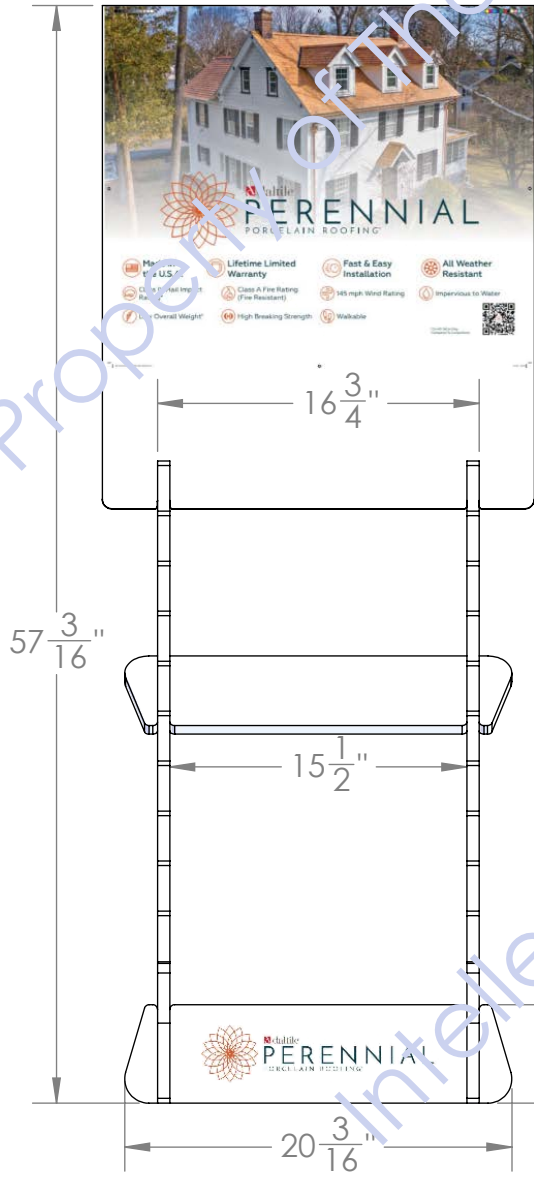
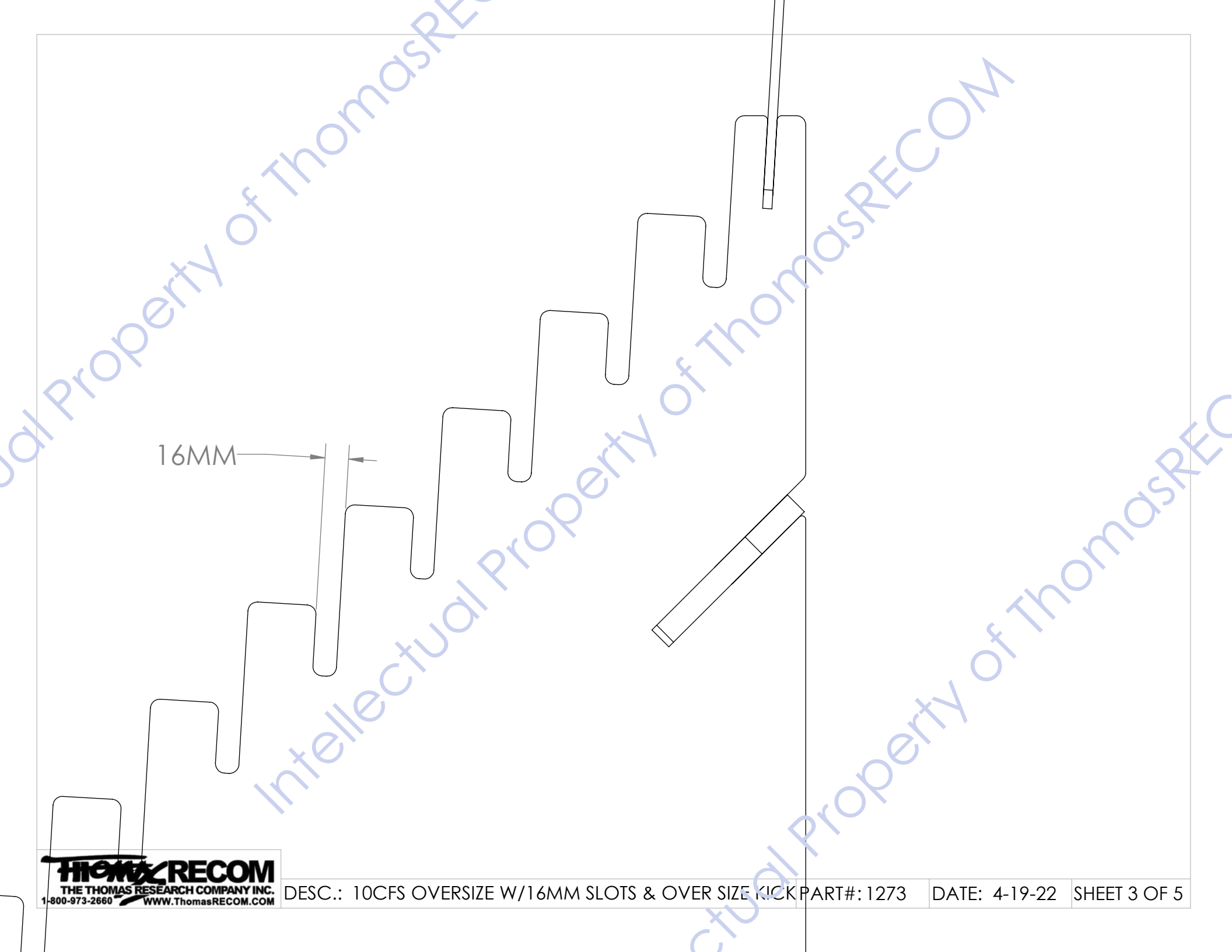

16MM

HEADER DIE-LINE DIMENSIONS (FROM TOP OF LAST TILE TO TOP OF HEADER)

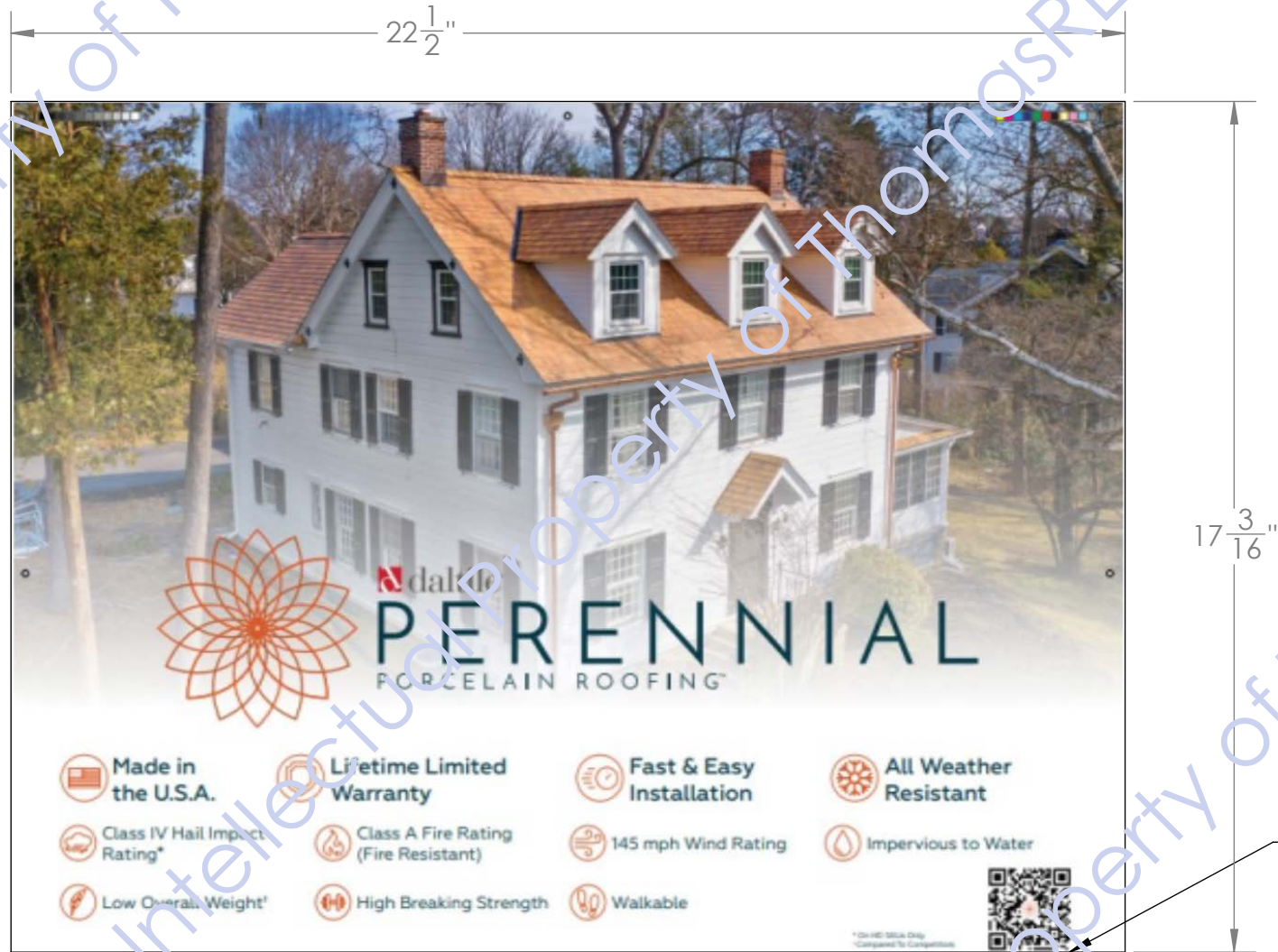

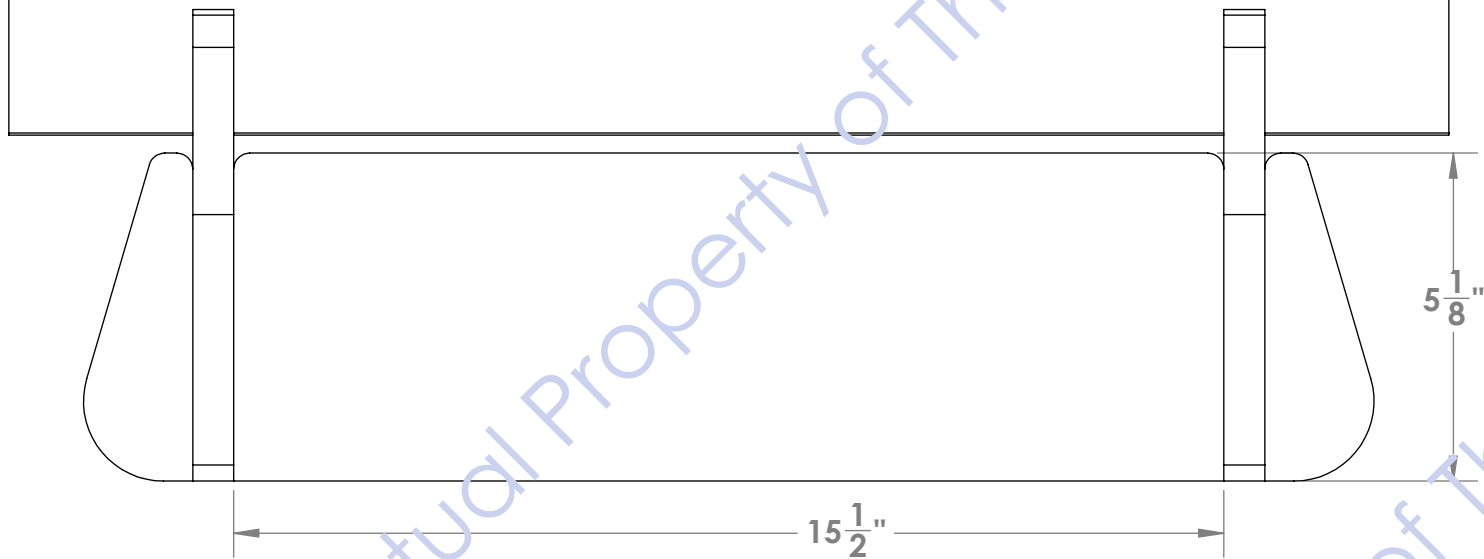

**FOOTER DIE-LINE DIMENSIONS
5-1/8" TALL X 15-1/2" TALL**